

# GYNECOLOGY

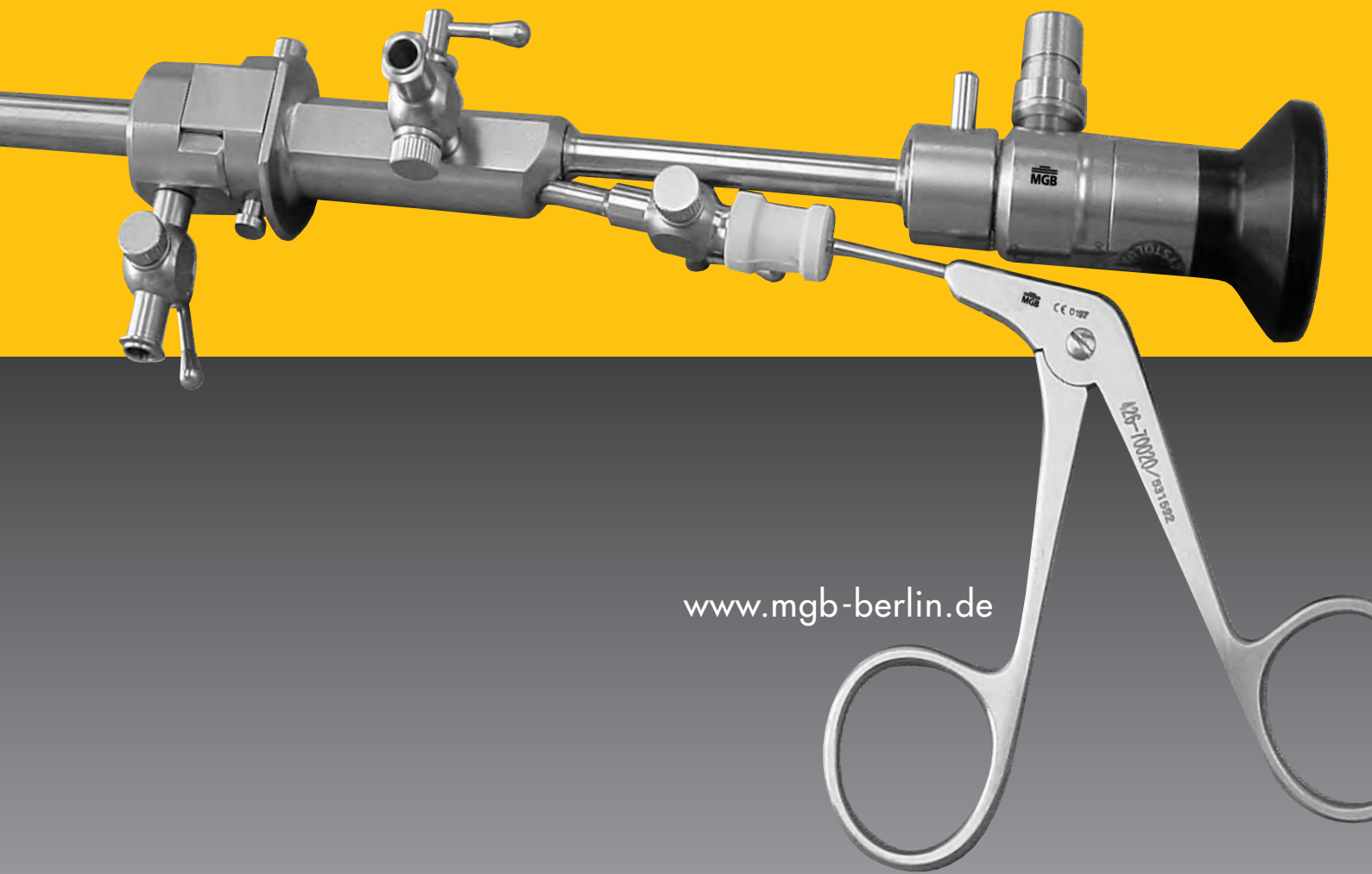

[www.mgb-berlin.de](http://www.mgb-berlin.de)

**MGB**

# CONTENT

**System for Ø 2.9 mm- Telescopes (Round Style)**

*Page 3-4*

**System for Ø 4.0 mm- Telescopes (Round Style)**

*Page 5-6*

**System for Ø 2.9/Ø 4.0 mm- Telescopes (Drop Style)**

*Page 7*

**Instruments**

*Page 8*

**Uterusmanipulator**

*Page 9*

**Irrigation - Pump**

*Page 10-11*

**Cohen - Probes**

*Page 12*

# HYSTEROSCOPY

## SYSTEM FOR Ø 2.9 mm - TELESCOPES

### Products

### Order-No.

### Description

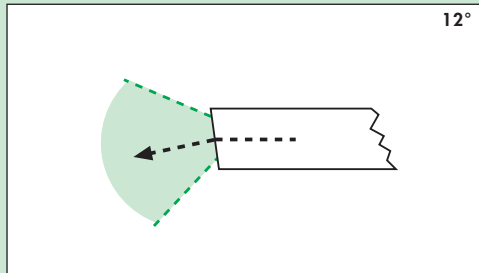

426-30000

#### Hystolux-Telescope 12°

- Direction of view 12°
- Outer-diameter: Ø 2.9 mm
- Working length: 300 mm
- Connector for Storz/Wolf/ACMI light guide

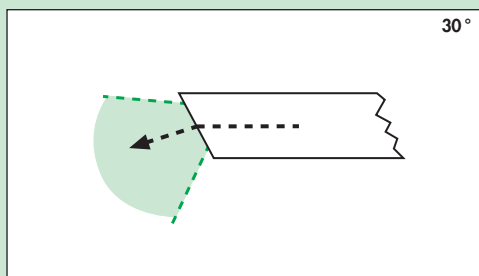

426-29000

#### Hystolux-Telescope 30°

- Direction of view 30°
- Outer-diameter: Ø 2.9 mm
- Working length: 300 mm
- Connector for Storz/Wolf/ACMI light guide

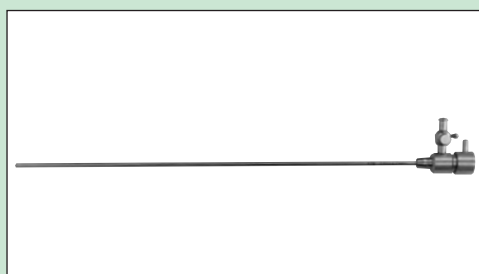

426-32920

#### Examination-Shaft

- For Ø 2.9 mm /30°- telescope
- Outer-diameter: Ø 3.7 mm
- Working length: 270 mm
- 1 Luer-Lock stopcock

Round Style

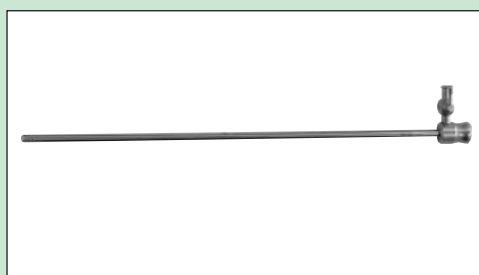

426-32922

#### Continuous Flow-Shaft for Examination-Shaft

- For Order-No.: 426-32920
- Outer-diameter: Ø 5 mm
- Working length: 260 mm
- Easy snap

Round Style

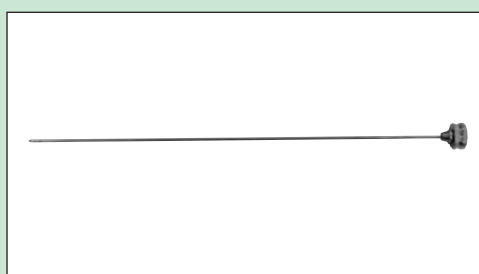

426-32910

#### Obturator for Examination-Shaft

- For Order-No.: 426-32920
- Tip like Hegar

# HYSTEROSCOPY

## SYSTEM FOR Ø 2.9 mm - TELESCOPES

Products

Order-No.

Description



### Continuous Flow-Operating Hysteroscope

Round Style

#### System consisting of:

426-32960  
426-32950  
426-32940  
426-29000

- Inner-shaft
- Outer-shaft
- Obturator
- Hystolux-Telescope 30°  
(see page 3)



426-32960

### Inner-Shaft for Ø 2.9 mm Operating-Hysteroscope

- For Ø 2.9 mm/30°-telescope
- Working channel: Ø 5 Fr. lockable
- 1 Luer-Lock stopcock
- With continuous flow

412-90001

### Sealing Caps for working channel

- 10 pcs.

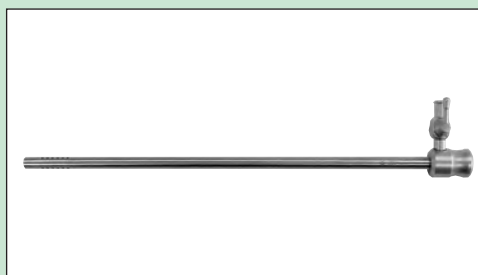

426-32950

### Outer-Shaft for Ø 2.9 mm Operating-Hysteroscope

Round Style

- Outer-diameter: Ø 5.9 mm
- Working length: 190 mm
- 1 Luer-Lock stopcock
- Easy snap
- With continuous flow

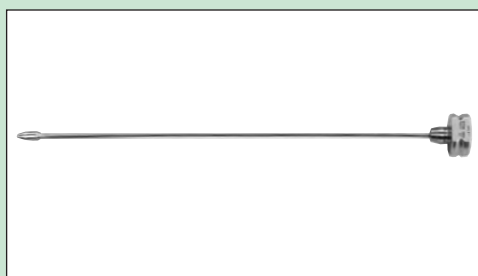

426-32940

### Obturator for Ø 2.9 mm Operating-Hysteroscope

- For outer-shaft
- For Order-No.: 426-32950
- Tip like Hegar

# HYSTEROSCOPY

## SYSTEM FOR Ø 4.0 mm-TELESCOPES

### Products

### Order-No.

### Description

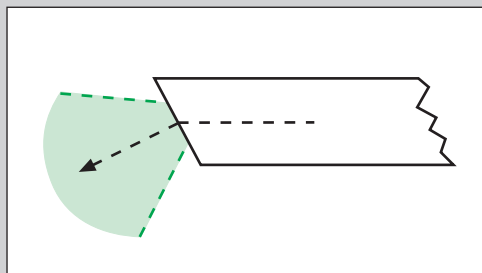

426-19500

#### Hystolux-Telescope 30°

- Direction of view 30°
- Outer-diameter: Ø 4 mm
- Working length: 300 mm
- Connector for Storz/Wolf/ACMI light guide

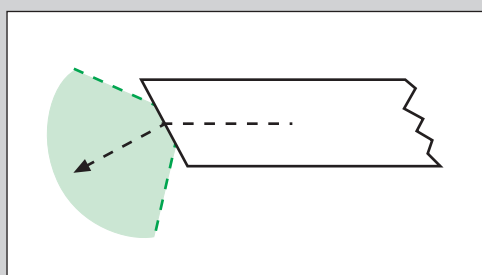

426-19600

#### Hystolux-Telescope 30°

*Wide-angle*

- Direction of view 30°
- Outer-diameter: Ø 4 mm
- Working length: 300 mm
- Connector for Storz/Wolf/ACMI light guide

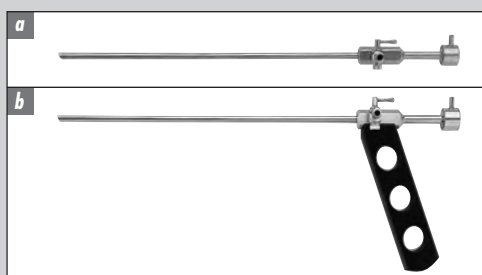

**a** 426-34020

#### **a** Examination-Shaft without Handle

*Round Style*

- For Ø 4 mm/30°-telescope
- Outer-diameter: Ø 5 mm
- Working length: 230 mm
- 1 Luer-Lock stopcock

**b** 426-34021

#### **b** Examination-Shaft with Handle

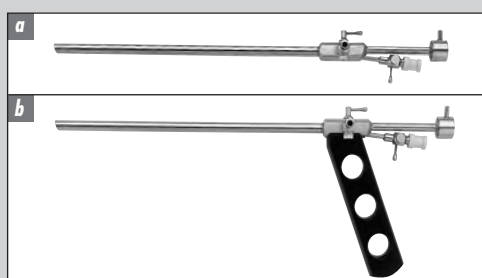

**a** 426-34030

#### **a** Working-Shaft without Handle

*Round Style*

- For Ø 4 mm/30°-telescope
- Outer-diameter: Ø 7.5 mm
- Working length: 205 mm
- Working channel: Ø 7 Fr. lockable
- 2 separate channels
- 1 Luer-Lock stopcock

**b** 426-34031

#### **b** Working-Shaft with Handle

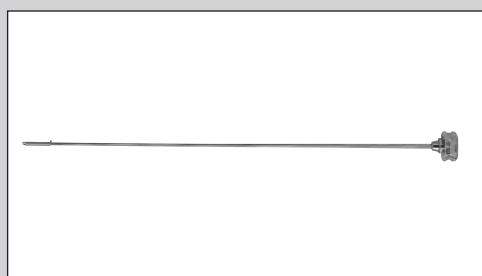

426-34010

#### Obturator

- For Order-No.:  
426-34020/426-34021  
426-34030/426-34031

# HYSTEROSCOPY

## SYSTEM FOR Ø 4.0 mm - TELESCOPES

Products

Order-No.

Description

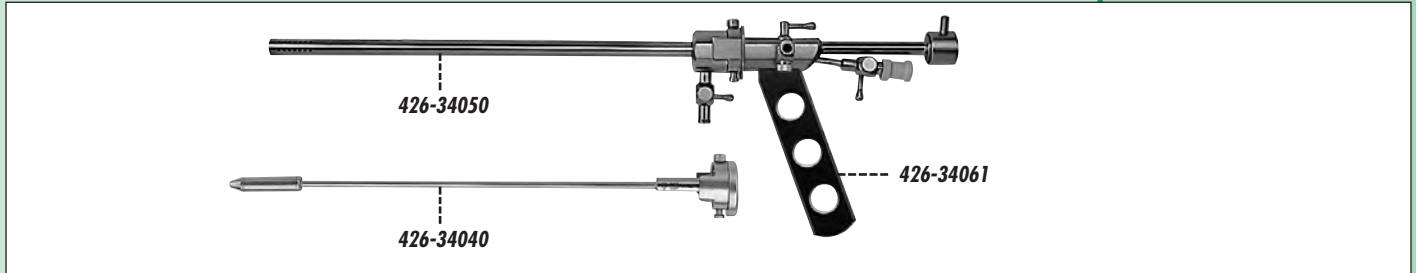

### Continuous Flow-Operating Hysteroscope

- With snap-in connection-system

#### System consisting of:

- Outer-shaft
- Obturator
- Inner-shaft **or**
- Inner-shaft with handle
- For Hystolux-telescope 30° **or**
- For Hystolux-telescope wide-angle 30°

426-34050  
426-34040  
426-34060  
426-34061  
426-19500  
426-19400

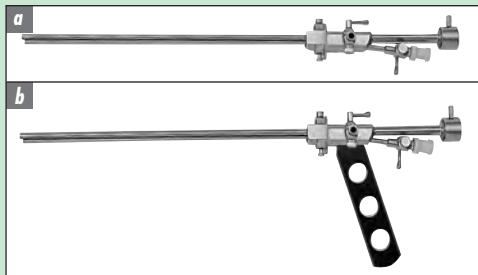

**a** 426-34060

### **a** Inner-Shaft for Operating-Hysteroscope without Handle

- For Ø 4 mm/30°-telescope
- Working channel: Ø 7 Fr. lockable
- 1 Luer-Lock stopcock

**b** 426-34061

### **b** Inner-Shaft for Operating-Hysteroscope with Handle

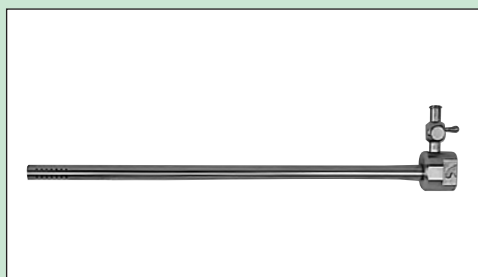

426-34050

### Outer-Shaft for Operating-Hysteroscope

- With continuous flow
- Outer-diameter: Ø 8 mm
- Working length: 180 mm
- 1 Luer-Lock stopcock

Round Style

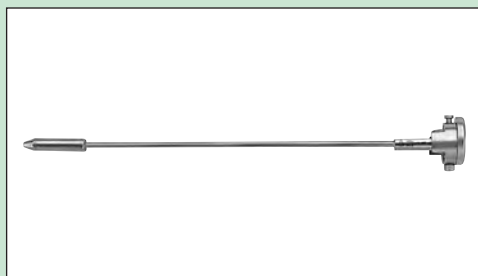

426-34040

### Obturator for Operating-Hysteroscope

- For outer-shaft (426-34050)

# HYSTEROSCOPY

## SYSTEM FOR Ø 2.9/Ø 4.0 mm-TELESCOPES

Products

Order-No.

Description

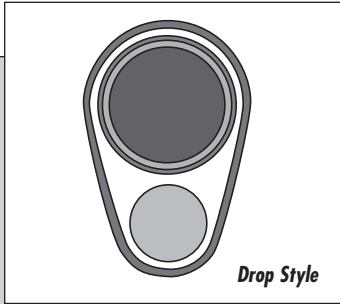

### Continuous Flow-Operating Hysteroscope

#### System consisting of:

- Inner-shaft
- Outer-shaft
- For Ø2.9 mm/Ø 4.0 mm telescope

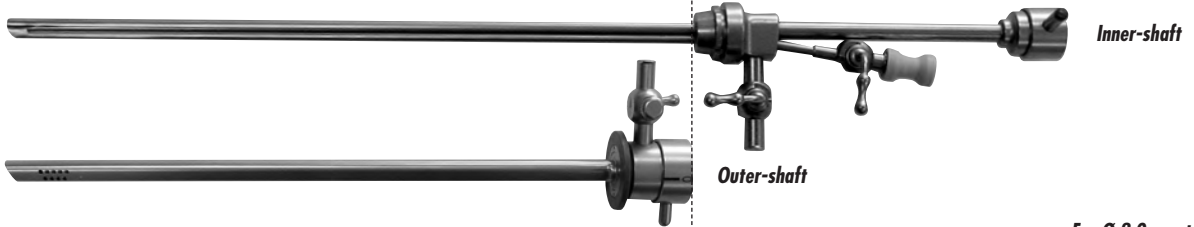

For Ø 2.9 mm telescope

426-32810

### Continuous Flow with 2 Stopcocks

- Drop style
- Working channel: Ø 5 Fr.
- Working length: 190 mm
- In-/outflow
- For telescope

Order-No. 426-29000

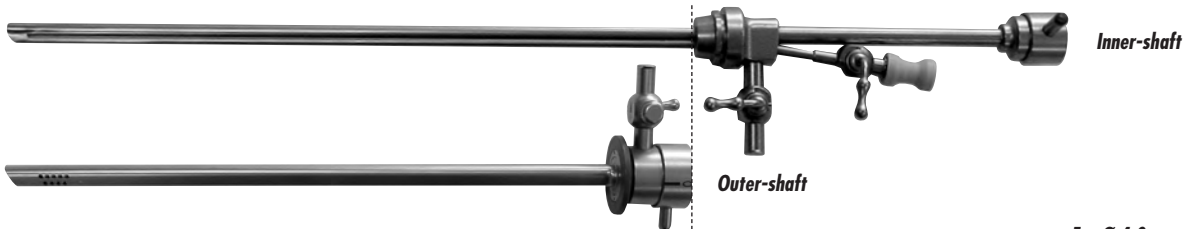

For Ø 4.0 mm telescope

426-32820

### Continuous Flow with 2 Stopcocks

- Drop style
- Working channel: Ø 5 Fr.
- Working length: 190 mm
- For telescope

Order-No. 426-19500

# HYSTEROSCOPY

## INSTRUMENTS

### Products

### Order-No.

### Description

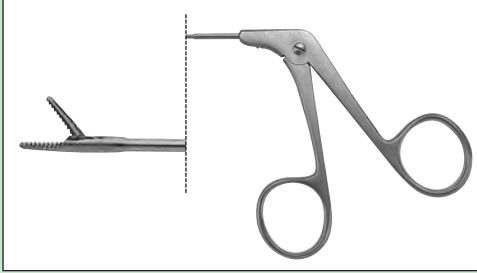

426-70010 (6 Fr.)  
(picture)

#### Semi Rigid Grasping Forceps

- Single-movable
- Working length: 320 mm

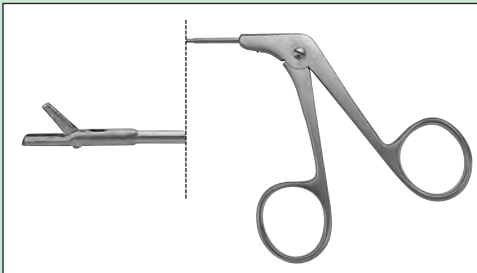

426-70015 (5 Fr.)

#### Semi Rigid Grasping Forceps

- Double-movable
- Working length: 320 mm

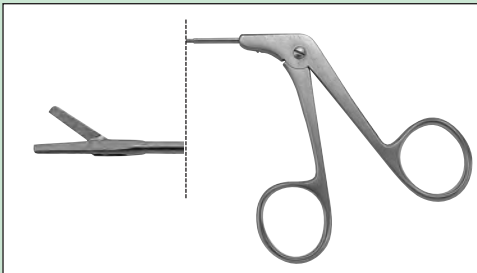

426-70020 (6 Fr.)  
(picture)

#### Semi Rigid Biopsy Punch

- Single-movable
- Working length: 320 mm

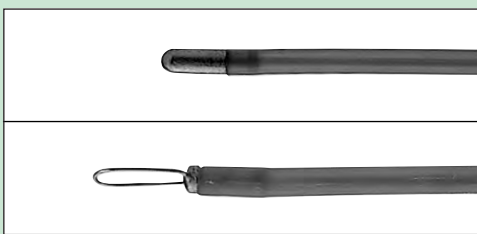

426-70025 (5 Fr.)

#### Semi Rigid Biopsy Spoon

- Double-movable
- Working length: 320 mm

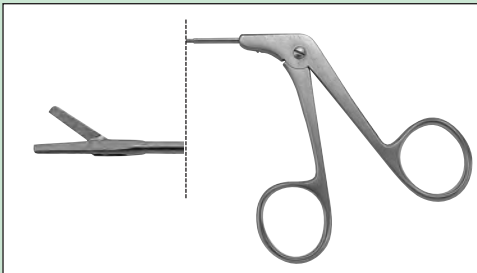

426-70030 (6 Fr.)  
(picture)

#### Semi Rigid Scissors Straight

- Single-movable
- Working length: 320 mm

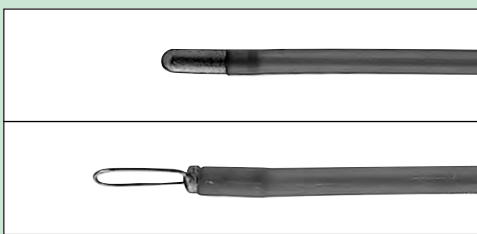

426-70035 (5 Fr.)

#### Semi Rigid Scissors Straight

- Single-movable
- Working length: 320 mm

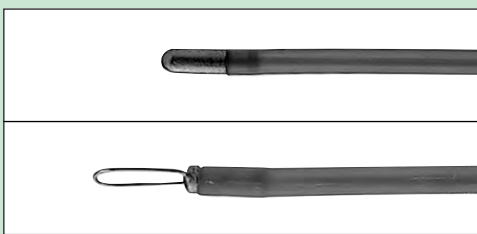

426-80010 (5 Fr.)  
426-80014 (4 Fr.)

#### HF-Button Electrode

- Working length: 530 mm



426-80020 (5 Fr.)

#### HF-Loop Electrode

- Working length: 530 mm



426-80030 (5 Fr.)  
426-80034 (4 Fr.)

#### HF-Needle Electrode

- Working length: 530 mm



426-80050

#### Uterus Grasping Forceps



## UTERUSMANIPULATOR

**Products**

**Order-No.**

**Description**



426-50110

**Uterusmanipulator**

■ Without adapter

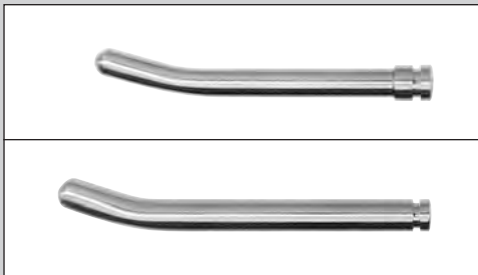

426-50116

**Adapter**

■ Ø 80 x 80 mm

426-50115

■ Ø 10 x 100 mm

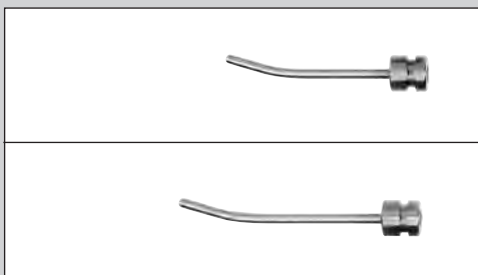

426-50114

**Adapter**

■ Ø 3 x 45 mm

426-50113

**Adapter**

■ Ø 3 x 55 mm

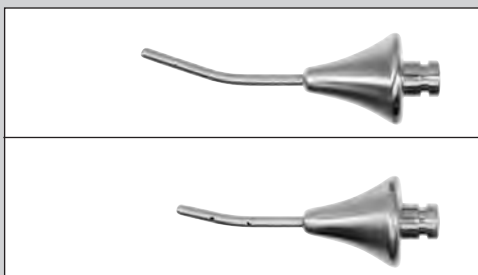

426-50112

**Adapter with Conus/long**

426-50111

**Adapter with Conus/short**

## HYSTEROSCOPY- PUMP

Order-No. 670-96800



### Intended Use

The device is an *Irrigation-Pump* with an optimal balancing system for hysteroscopic application. It is used to introduce fluids into the vacuum uteri.

### Indications

The device is indicated for liquid distension of the uterus for diagnostic and operative hysteroscopic and monitoring the volume differential between the irrigation fluid flowing into and out of the uterus.

### Technical Application Scope of the Device

The nominal value for the intrauterine pressure and the desired flow rate can be set at the device. The nominal pressure can be preset to ranges between 15 to 100 mg Hg and 100 to 150 mg Hg. The nominal flow has three increments and can be preset to between 30-500 ml/min.

All devices to be connected to the *Hysteroscopic-Pump* have to correspond to the IEC-601 standards and to other actual IEC/ISO standards valid for particular devices.

## GENERAL

<i>Order-No.</i>	
<b>670-96800</b>	Irrigation-Pump
<i>Main Connection</i>	
Power supply	~100 - 250 V
Frequency	50 - 60 Hz
Power consumption	45 VA
<i>Classification</i>	
Safety class	1 with potential equalization connection
Protection	IP 41
Type	BF
Approval	CE, II b
Pressure range	15-150 mm Hg
Flow rate	30-500 ml/min.
High pressure safety	200 mm Hg
<i>Extent of Delivery</i>	
Irrigation-Pump	<ul style="list-style-type: none"> <li>■ User manual</li> <li>■ Main power cable</li> </ul>

## SPECIFICATION

<i>Connection</i>	
Container scale and bottle scale	
<i>Dimension and Weight</i>	
Dimension (w/h/d)	360 x 268 x 137 mm
Weight	4 kg

<i>Order-No.</i>	<i>Accessories</i>
<b>670-96410</b> (1 pc.)	Limited use tubing set, Silicone (inflow)
<b>670-96420</b> (10 pcs.)	Disposable tubing set, PVC (inflow)
<b>670-96505</b> (10 pcs.)	Disposable tubing set, PVC (outflow) to scales
<b>670-96520</b>	Bottle scale
<b>670-96460</b> (10 pcs.)	Membrane for pressure chambre for limited use for tubing set

# HYSTEROSCOPY

## COHEN-PROBES

Products

Order-No.

Description



426-50103

**Cohen Probe**

- Complete incl. adapter

426-50100

**Consisting of:**

- Cohen-probe without adapter

426-50101

**Portio Adapter/small**

- Ø: 18 mm
- L: 28 mm

426-50102

**Portio Adapter/large**

- Ø: 24 mm
- L: 30.5 mm

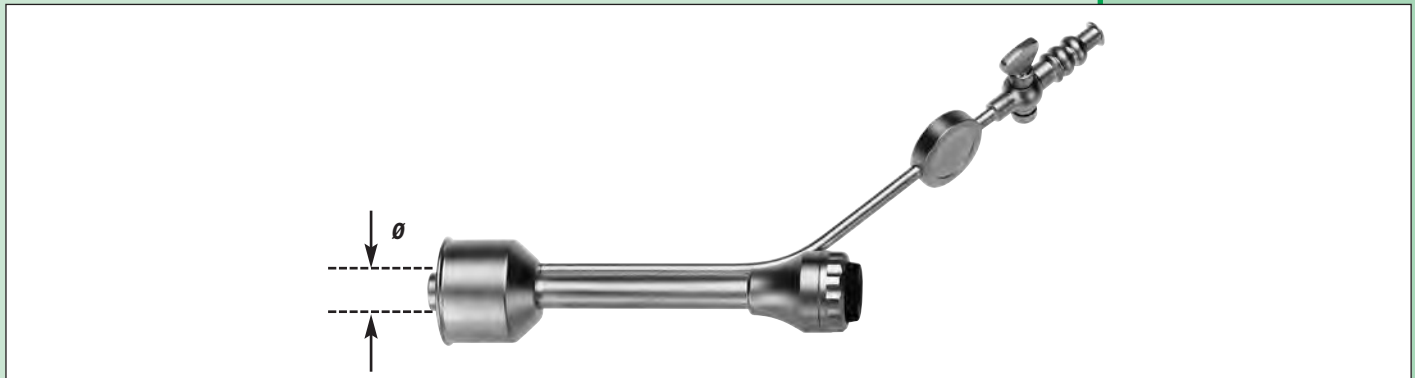

426-50105

**Hysteroscopy Adapter/small**

- Ø: 10.5 mm

426-50106

**Hysteroscopy Adapter/large**

- Ø: 16 mm



MGB Endoskopische Geräte GmbH Berlin

Schwarzschildstrasse 6 · 12489 Berlin, Germany

Phone: +49-30-63 92 -70 10

Fax: +49-30-63 92 -70 11

E-mail: sales@mgb-berlin.de

Internet: www.mgb-berlin.de



**Delrus Europe Kft.**

Allee Corner Business Center

Corner Tower, 4th floor

Hungary, 1117 Budapest, Október 23. utca 8-10.

Tel.: +36 1 882-3579,

Fax: +36 1 882-3501

E-mail: delrus.e@delruseurope.com

Web: www.delruseurope.com